

# SERVICE MANUAL

## Level 1&2

# NOKIA N800

RX-34

**Transceiver characteristics:****Band:** -----**Camera:** VGA camera**Display:** 10.49cm (4.13inch) Touch screen with 65.536 colors,  
High resolution 800x480 pixel**WLAN:** IEEE802.11 g/b**Bluetooth****FM Radio****Connector:** Mini USB Connector**Memory Card Type:** SD/MMC**Transceiver withBP-5L Li-Ion battery pack**

Talk time	Standby	Note
-----	up to 10days	Depends on network parameters

**Environmental characteristics:**

- Lead-free soldered

**TABLE OF CONTENTS**

Page

1.	<b>INTRODUCTION</b>	<b>3</b>
2.	<b>GENERAL REPAIR INFORMATION</b>	<b>4</b>
3.	<b>PATHFINDER FOR WORKSHOP STAFF</b>	<b>5</b>
4.	<b>EXPLODED VIEW</b>	<b>6</b>
5.	<b>SPARE PARTS OVERVIEW</b>	<b>7</b>
6.	<b>GENERAL RECYCLING RECOMMENDATION</b>	<b>8</b>
7.	<b>LEVEL 2 SOLDER COMPONENTS</b>	<b>9</b>
8.	<b>NOKIA ONLINE (NOL)</b>	<b>10</b>
9.	<b>SERVICE TOOLS</b>	<b>11</b>
10.	<b>SW-UPDATE</b>	<b>13</b>
11.	<b>DISASSEMBLY INSTRUCTION</b>	<b>14</b>
12.	<b>ASSEMBLY HINTS</b>	<b>19</b>
13.	<b>LEGEND FOR QUICK TROUBLE SHOOTER</b>	<b>20</b>
14.	<b>QUICK TROUBLE SHOOTER - POWER ON</b>	<b>21</b>
15.	<b>QUICK TROUBLE SHOOTER - CHARGING</b>	<b>22</b>
16.	<b>QUICK TROUBLE SHOOTER - WLAN</b>	<b>23</b>
17.	<b>QUICK TROUBLE SHOOTER - IHF SPEAKER</b>	<b>24</b>
18.	<b>QUICK TROUBLE SHOOTER - DISPLAY</b>	<b>25</b>
19.	<b>QUICK TROUBLE SHOOTER - MICROPHONE</b>	<b>26</b>
20.	<b>QUICK TROUBLE SHOOTER - KEYMAT FRONT</b>	<b>27</b>
21.	<b>QUICK TROUBLE SHOOTER - KEYMAT TOP</b>	<b>28</b>
22.	<b>QUICK TROUBLE SHOOTER - AV CONNECTOR</b>	<b>29</b>
23.	<b>QUICK TROUBLE SHOOTER - USB CONNECTOR</b>	<b>30</b>
24.	<b>QUICK TROUBLE SHOOTER - CARD READER</b>	<b>31</b>
25.	<b>QUICK TROUBLE SHOOTER - CAMERA</b>	<b>32</b>

**CHANGE HISTORY**

Status	Version No.	Date	Comments
Draft	0.1	08.Dec.2006	Initial draft
Approved	1.0	09.Jan.2007	Approval
Approved	2.0	14.Mrz.2007	Exploded view / Spare Parts overview update; Battery Test / GONOGO Test removed

## 1. INTRODUCTION

The purpose of this document is to help NOKIA service levels 1 and 2 workshop technicians to carry out service to NOKIA products. This Service Manual is to be used only by authorized NOKIA service suppliers, and the content of it is confidential. Please note that NOKIA provides also other guidance documents (e.g. Service Bulletins) for service suppliers, follow these regularly and comply with the given instructions.

While every endeavor has been made to ensure the accuracy of this document, some errors may exist. If you find any errors or if you have further suggestions, please notify NOKIA using the address below:

<mailto:cc-ts-rc.documentation@nokia.com>

Please keep in mind also that this documentation is continuously being updated and modified, so watch always out for the newest version.

### Warnings and Cautions

Please refer to the phone's user guide for instructions relating to operation, care and maintenance including important safety information. Note also the following:

#### Warnings:

1. CARE MUST BE TAKEN ON INSTALLATION IN VEHICLES FITTED WITH ELECTRONIC ENGINE MANAGEMENT SYSTEMS AND ANTI-SKID BRAKING SYSTEMS. UNDER CERTAIN FAULT CONDITIONS, EMITTED RF ENERGY CAN AFFECT THEIR OPERATION. IF NECESSARY, CONSULT THE VEHICLE DEALER/MANUFACTURER TO DETERMINE THE IMMUNITY OF VEHICLE ELECTRONIC SYSTEMS TO RF ENERGY.
2. THE HANDPORTABLE TELEPHONE MUST NOT BE OPERATED IN AREAS LIKELY TO CONTAIN POTENTIALLY EXPLOSIVE ATMOSPHERES, EG PETROL STATIONS (SERVICE STATIONS), BLASTING AREAS ETC.
3. OPERATION OF ANY RADIO TRANSMITTING EQUIPMENT, INCLUDING CELLULAR TELEPHONES, MAY INTERFERE WITH THE FUNCTIONALITY OF INADEQUATELY PROTECTED MEDICAL DEVICES. CONSULT A PHYSICIAN OR THE MANUFACTURER OF THE MEDICAL DEVICE IF YOU HAVE ANY QUESTIONS. OTHER ELECTRONIC EQUIPMENT MAY ALSO BE SUBJECT TO INTERFERENCE.

#### Cautions:

1. Servicing and alignment must be undertaken by qualified personnel only.
2. Ensure all work is carried out at an anti-static workstation and that an anti-static wrist strap is worn.
3. Use only approved components as specified in the parts list.
4. Ensure all components, modules screws and insulators are correctly re-fitted after servicing and alignment.
5. Ensure all cables and wires are repositioned correctly.



Electrostatic discharge can easily damage the sensitive components of electronic products. Therefore every Service Supplier has to take care of all precautions, which are mentioned in the service level related "Service Partner Requirements", available on NOKIA Online. Also see ESD Protection Requirements in this Service Manual.

## 2. GENERAL REPAIR INFORMATION

In this section the technician will get some general hints how to carry out repairs:

- To familiarize oneself with NOKIA product read the tutorials or user guide on [www.nokia.com](http://www.nokia.com) -->Support--> Phones, by selecting the Phone Model.
  - Before starting the repair you must take care of ESD precautions like being in your ESD Protected Area and connecting your wristband.
  - Use gloves to avoid corrosion and fingerprints.
  - Protect windows and displays with a film to avoid dust and scratches.
  - When cleaning the LCD Module any lint-free cloth can be used (e.g. Micro-Fibre cloth).
  - When cleaning the pads you have to use a soft cloth/ESD brush and Isopropanol. It is not allowed to use a glass fiber pencil because it scratches the surface and will lead later on to corrosion.
  - Mechanical parts (except shielding lids and bent parts), which didn't repair the failure, can be reused, if they are not soldered.
  - When removing the shielding lids make sure to replace them with new ones, otherwise the high-frequency leakage can have an influence on the device.
  - Always use original NOKIA spare parts.
  - Check the soldering joints of the parts, which are concerned regarding the indicated error (e.g. soldered connectors or switches) and resolder them if necessary (Level 2 only).
  - Remove redundant soldering flux after repair.
  - Meet the torque requirements when assembling the unit (see also the document "torques for transceiver assembly" on NOKIA Partner Web Site/NOKIA Online).
  - Always use your own equipment for testing where you are sure that it works. E.g. if the customer complains about charger function, please test the phone with your own charger to be sure if phone or charger causes the malfunction.
  - A SIM card is needed for all GoNoGo tests.
  - When doing the fault log entries, always note the Item code, which caused the malfunction. Also, fill in the appropriate part code from the assembly, if needed.
  - Please be aware that some malfunctions could be software related and solved by an update.
- 
- There are several documents available on NOL, which have to be followed:
  - 
  - First, take care for the latest content pages of Service Bulletins, which are always available for each folder on NOKIA Online. This is also important to recognize, if existing documents have become invalid.
  - 
  - The service level indicator at the bottom of each document tells the appropriate destination.

Downloads > Support Library >

1. Instructions
  2. General Service Bulletins
  3. Product related documents
  4. Spare Part Service Bulletins
  5. Service Tools Service Bulletins
  6. Common Software Service Bulletins
- etc,...

Use General SB-217 as a reference or overview.

Please also check NOKIA Online (NOL) for latest news and files on a regular basis.

### 3. PATHFINDER FOR WORKSHOP STAFF

**This is the NOL page (NOKIA Online) which is currently available in Europa, Middle East and Africa only!**

In addition to the information in this Service Manual, there are several instructions and information, which have to be followed. Main documentation database is [NOKIA Online](#) with the purpose of serving different multimedia content, like video clips or interactive tutorials.

It is mandatory to watch for newest technical and organizational information on a daily basis to be updated as required (see **“Latest files in Support Library”**). Every new information has to be processed and implemented as soon as possible.

When logged into NOL you can also find needed information in different folder like:

#### Support Library



- Service Manuals
- Service Bulletins
- Software
- Repair Information

#### Level 1&2 e-learning (former NOKIA CarePoint) on NOKIA Online

Former NOKIA CarePoint content, such as	<ul style="list-style-type: none"> <li>• <b>Online Troubleshooting</b></li> <li>• <b>Product information</b></li> <li>• <b>Videos – Disassembly/Assembly</b></li> </ul>	can be found on <b>NOKIA Online</b>
		<p><b>NOKIA Online</b></p> <p>↓</p> <p><b>Care Services</b></p> <p>↓</p> <p><b>Training</b></p> <p>↓</p> <p><b>Phone Models</b></p>

Level 1&2 e-learning courses offer a quick overview of the NOKIA phone and support for how to repair and use the phone:

<p><b>Overview &amp; Guides</b> Basic information about the phone, features and technologies</p>	<p><b>Disassembly &amp; Assembly</b> Instructions how to disassemble and assemble the phone</p>	<p><b>Troubleshooting</b> Step-by-step instructions on how to locate and repair the most common problems with the phone</p>
--	---	---

To reduce the server traffic it is recommended to download newest version of huge files like videos, Phoenix packages or Service Manuals only once and distribute it internally for further use.





## 4. EXPLODED VIEW

See corresponding ITEM/CIRCUIT REF in the Spare Parts Service Bulletins on NOL.

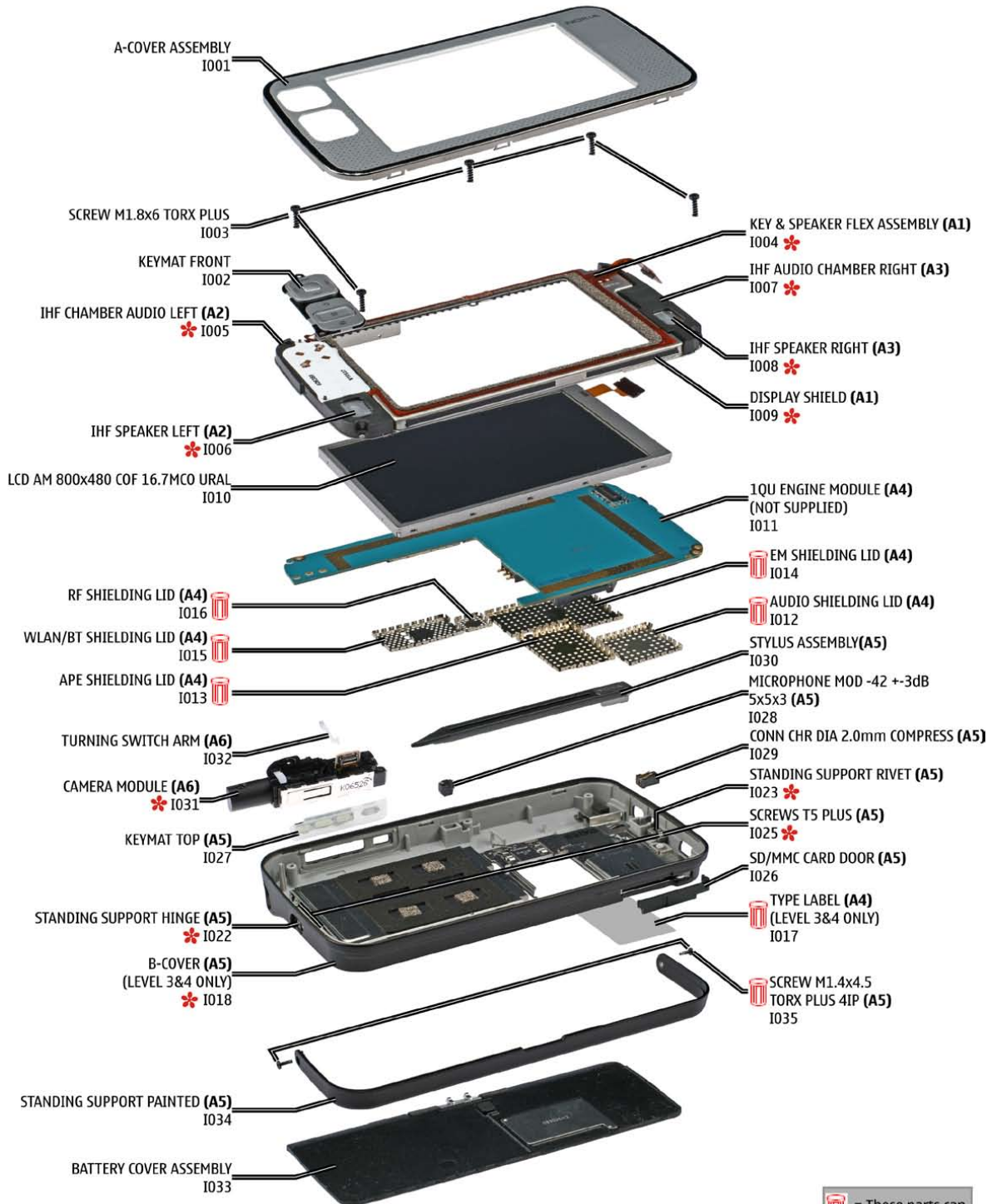
### N800 RX-34 EXPLODED VIEW



 = These parts can not be reused after removal.

 = only available as assembly

Ver. 2.0

## 5. SPARE PARTS OVERVIEW

### N800 RX-34 SPARE PARTS OVERVIEW

#### A1=DISPLAY SHIELD ASSEMBLY (I004,I009, A2, A3)

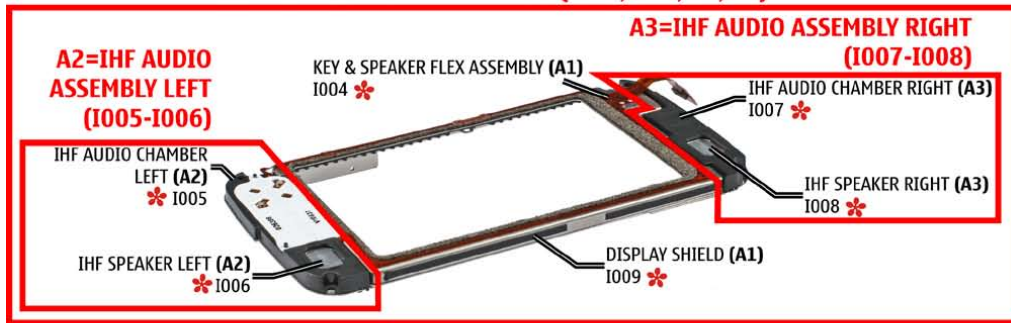

#### A4=1QU ENGINE MODULE (I011-I017)

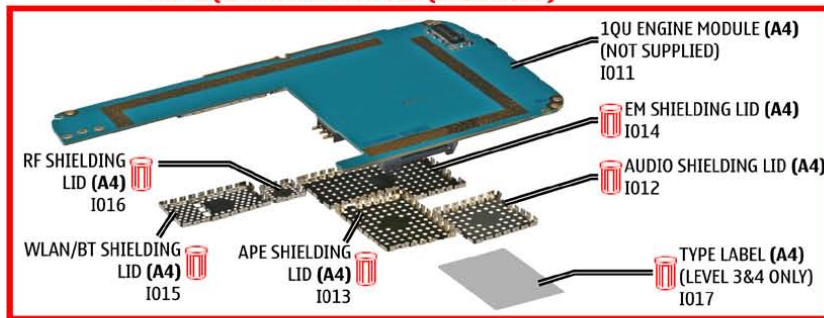



#### A6=CAMERA MODULE ASSY (I031-I032)

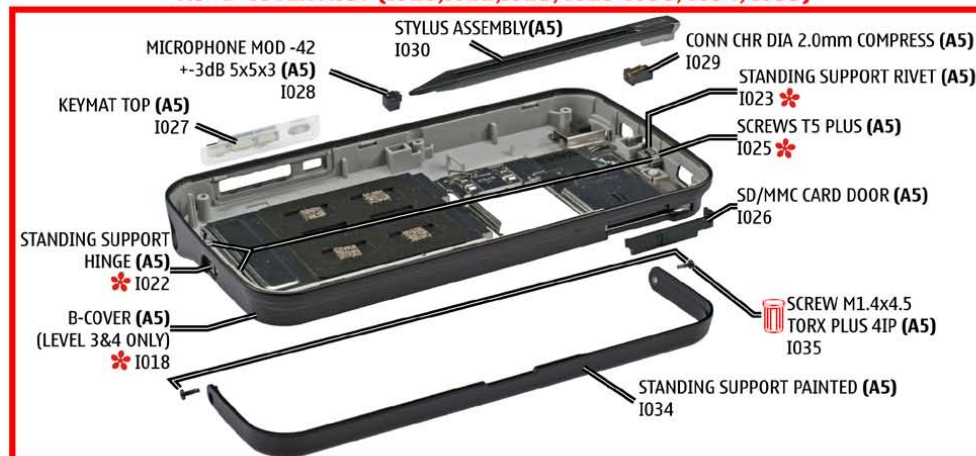

#### A5=B-COVER ASSY (I018,I022,I023, I025-I030, I034, I035)



 = These parts can not be reused after removal.

 = only available as assembly

Ver. 2.0



## 6. GENERAL RECYCLING RECOMMENDATION

**NOKIA**

CMO Operations & Logistics  
Training and Vendor Development  
Multimedia Creation & Support

Confidential

13.11.2006

MGR

### General Recycling recommendation

**100% - only one Material**  
(Example components)

**METAL**

**PLASTIC**

**Mixed components**  
(Example components)

**ELECTRO-MIX**

**ELECTRO-MIX: Most components made of Glass, Ceramics, Glassfiberreinforced epoxy.**  
**ALL fractions containing any copper should be send to ELECTRO-MIX!!!**

**METAL - MIX**

**METAL-MIX: Most components made of Metal**

**BATTERY**

**BATTERY: Chemicals, Plastic and Ceramics**

**PLASTIC-MIX**

**PLASTIC-MIX: Most components made of Plastic**

Some of these options can be utilized directly and some need pretreatment as for instance dismantling, grinding, milling, etc.  
For sorting the waste into fractions for recycling, your recycler will offer you more specific information, but a **GENERAL RULE** is:

**Electronic Equipment:** There are recyclers that can process this "multimaterial" for high recycling yields.

**Metals:** Fractions containing metals must always be collected and sent for (metal) material recycling.

**Plastics:** Pure plastics fractions (i.e. covers) can be sent for (plastics) materials recycling.

**Mixed Plastic/Metals:** A metal fraction contaminated with plastics does not represent a problem for metal recycling/recovery whereas recycling/recovery of plastics is generally sensitive for contamination by other materials.

● ELECTRO ● METAL ● PLASTIC ● BATTERY

Ver. 3.0

Copyright © 2006 NOKIA Corporation. All rights reserved



## 7. LEVEL 2 SOLDER COMPONENTS

### N800 RM-34 Level 2 Solder components

**Solder components only for LEVEL 2**

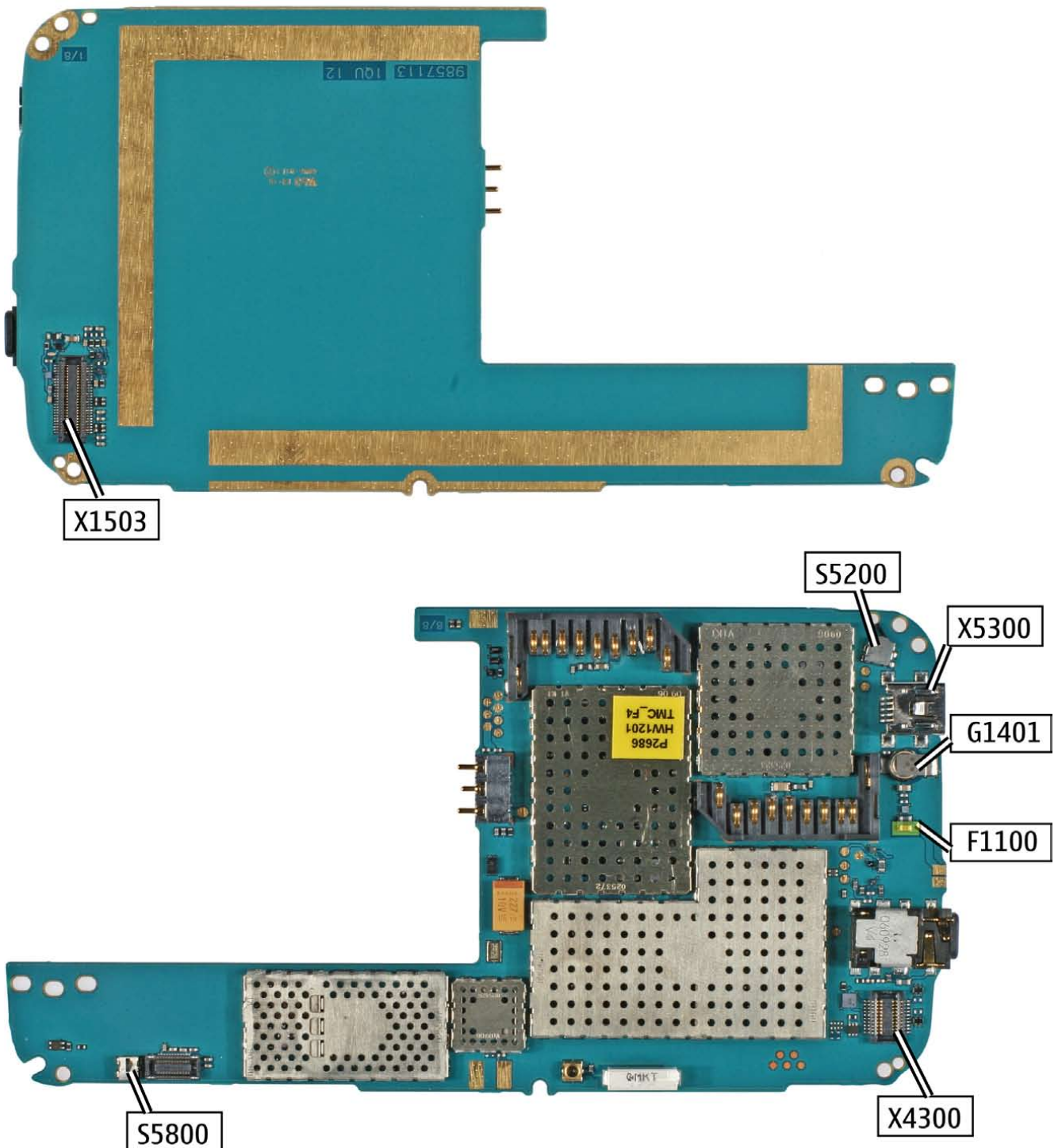

## 8. NOKIA ONLINE (NOL)

NOL is the database where you can find the latest corresponding Service Bulletins (spare parts, SWAP units and service tools).

This will ensure, that you are using up-to-date order codes only.

Therefore Service Bulletins have to be checked from NOL on daily basis.

---

[Home](#) | [User](#) | [Sitemap](#) | [Log Out](#)

Nokia Online

GO

Care ServicesSupport LibraryWarranty InfoService PointsTraining

### Support Library

#### Browse files

Latest files

» Browse files

Select category:

Select subcategory:

Select subcategory:

---

Date range from:  /  /

until:  /  /

Search:  SEARCH

---

**Files for Service level 2** Date:03.02.2005

- XXXXXXXXXXXXXXXXXXXX





---

**Files for Service level 1** Date:16.02.2005

- XXXXXXXXXXXXXXXXXXXX
- XXXXXXXXXXXXXXXXXXXX
- XXXXXXXXXXXXXXXXXXXX

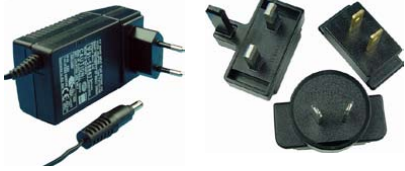
© Nokia 2005 [legal notice and site usage terms](#) | [privacy policy](#).

**9. SERVICE TOOLS**

	<p><b>FLS-4s incl. ACF-8, Driver and User Guide</b> Dongle and flash device incorporated into one package, developed specifically for POS use.</p>
	<p><b>ACF-8</b> Universal Power Supply is used to power FLS-4S.</p>
	<p><b>Travel Charger AC-4</b> Small and lightweight charger for fast charging of your phone battery.</p>
	<p><b>Internal Battery BP-5L</b> Inserted under the back cover, this Li-Ion battery provides power in a lightweight package.</p>
	<p><b>DKE-2</b> Service Cable to connect the PC with the Mini USB connector.</p>
<p>RJ-120</p> 	<p><b>RJ-120</b> Soldering Jig</p>



**Lead-free Solder Wire**

Mandatory for lead-free products (Level 2 only).

**NOKIA Standard Toolkit V2**



**0772040**

**NMP Standard Toolkit (V2)**

For more informations refer to the Service Bulletin (SB-011) on NOKIA Online.

Supplier or manufacturer contacts for tool re-order can be found in **“Recommended service equipment”** document on NOKIA Online.



## 10.SW-UPDATE

### Flash Concept – (Point of Sales)

To use FLS-4s Flash Dongle you have to follow the user guide inside the sales package. Please check always for the latest version of flash software, which is available on [NOKIA Online](#).

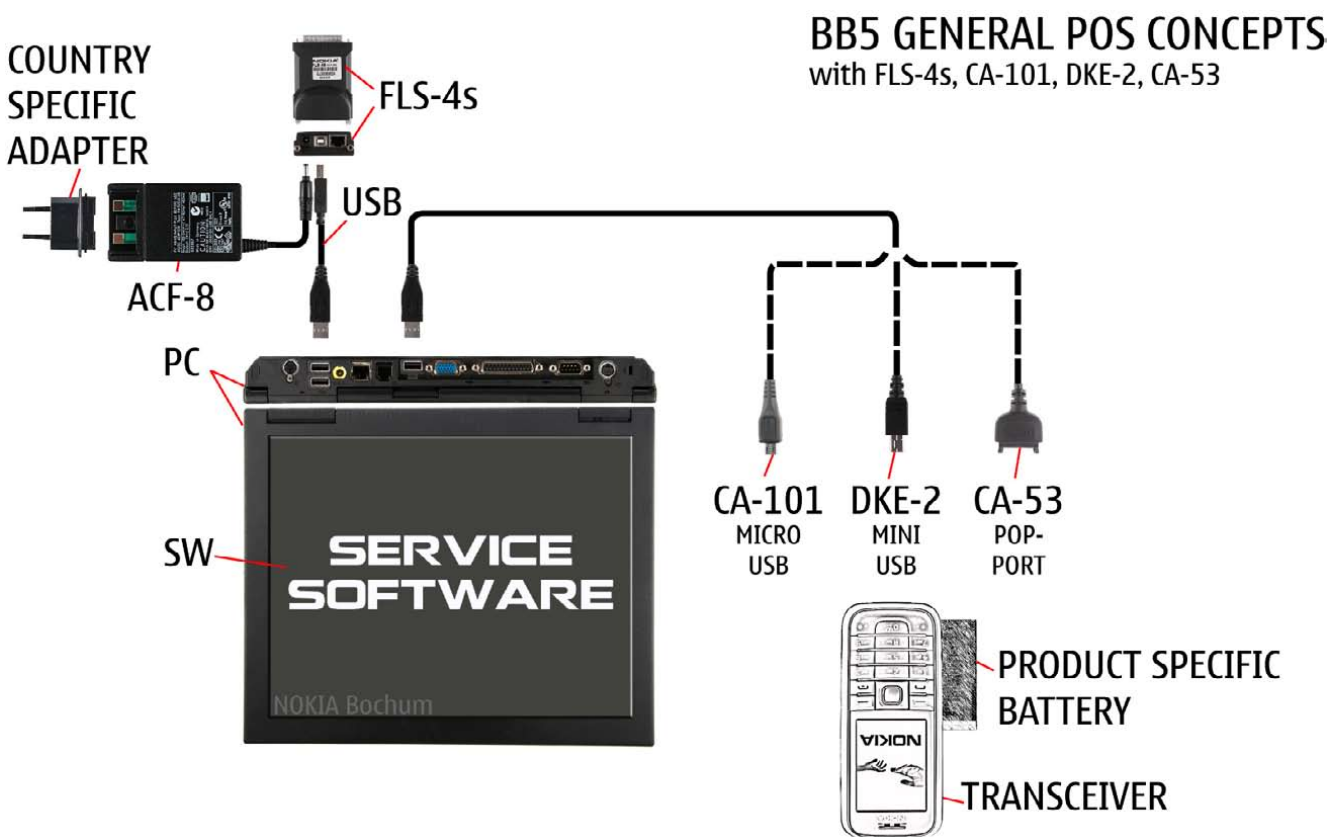

**11. DISASSEMBLY INSTRUCTION**

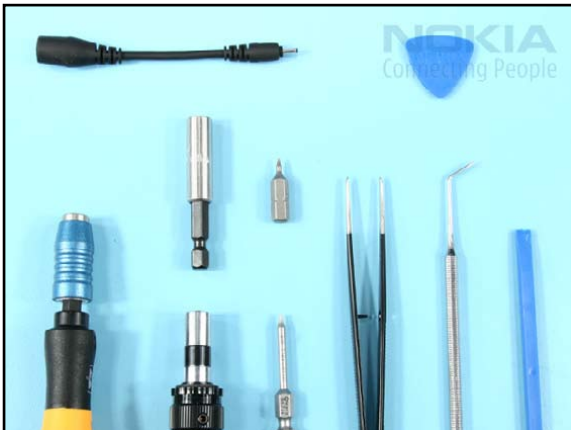

1. Needed tools: a Torx driver, a torque driver, a bit holder, a Torx Plus size 4 bit, a Torx Plus size 6 bit, metal tweezers, a dental pick, the SS-93, the SRT-6 and the DC-plug



2. Press the RELEASE BUTTON and remove the BATTERY COVER ASSEMBLY. Remove the BATTERY if inserted.



3. Remove the STYLUS ASSEMBLY.



4. Undo the two Torx Plus size 4 screws in the order shown.



5. Discard the screws after removal.



6. Remove the STANDING SUPPORT PAINTED. Note the correct position when assembling the unit.



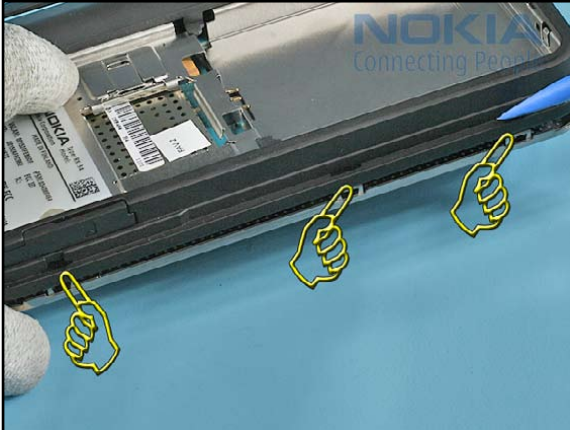

7. Release the three clips of the A-COVER with the SS-93.



8. Lift the shown side of the A-COVER and remove it carefully.



9. Remove the KEYMAT FRONT.

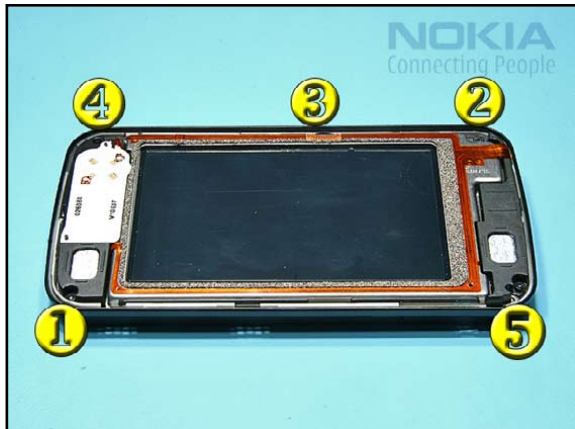

10. Undo the five Torx Plus size 6 screws in the order shown. The screws can be reused only one time.



11. Lift the DISPLAY SHIELD ASSEMBLY a bit with the SS-93.



12. Carefully, turn the unit as shown by securing the LCD with a clean cloth.





13. First push in the CAMERA MODULE and then pull it out from its place.



14. Carefully, place the ENGINE MODULE with the CAMERA MODULE onto DISPLAY SHIELD ASSEMBLY.



15. Remove the B-COVER.

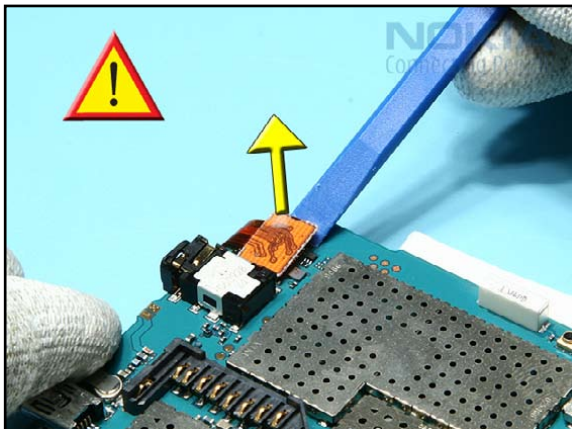

16. Gently, open the connector of the DISPLAY SHIELD ASSEMBLY.

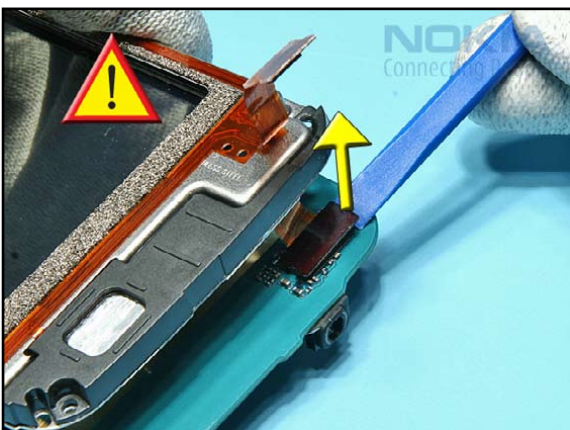

17. Open the LCD connector carefully ...

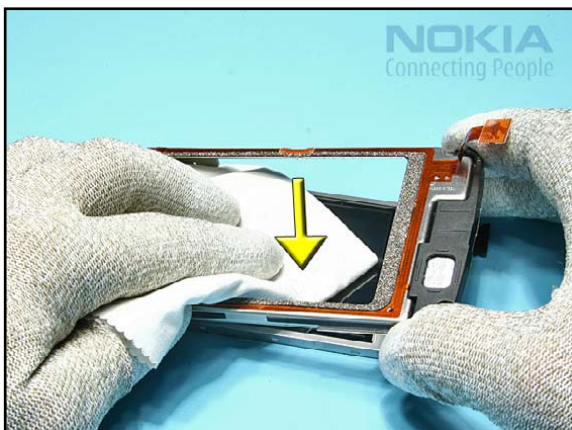

18. and separate the LCD from the DISPLAY SHIELD by pressing out the LCD with a clean cloth.



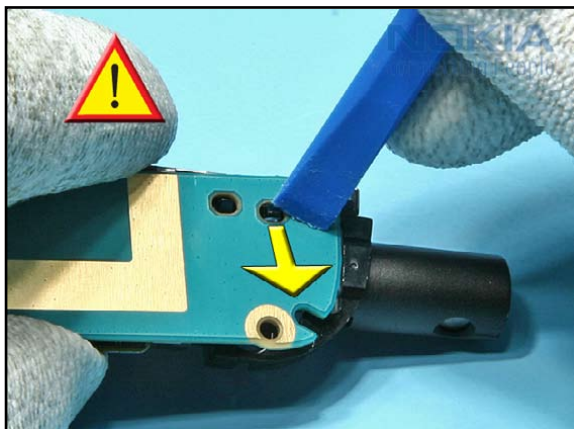

19. Unlock the snaps of the CAMERA MODULE with the SS-93.

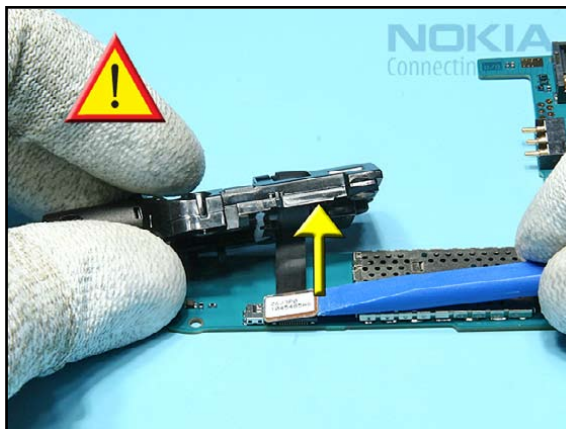

20. Gently, disconnect the CAMERA MODULE from the ENGINE MODULE.



21. Remove the KEYMAT TOP.

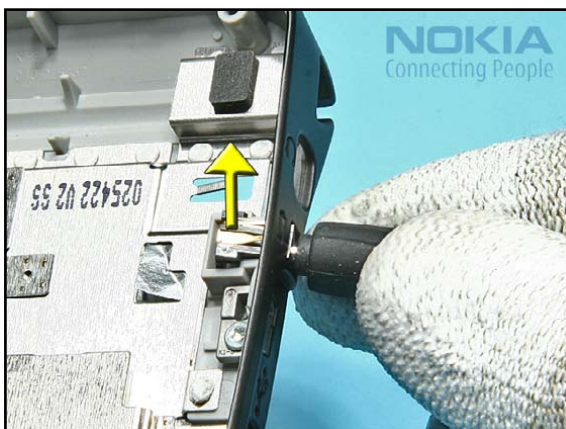

22. Use the DC-plug to remove the DC-JACK.

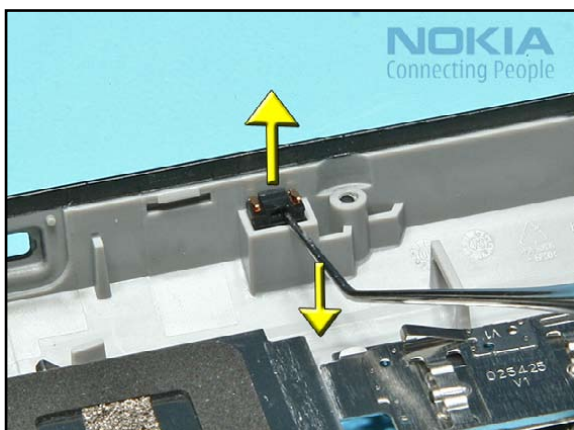

23. Remove the MICROPHONE.

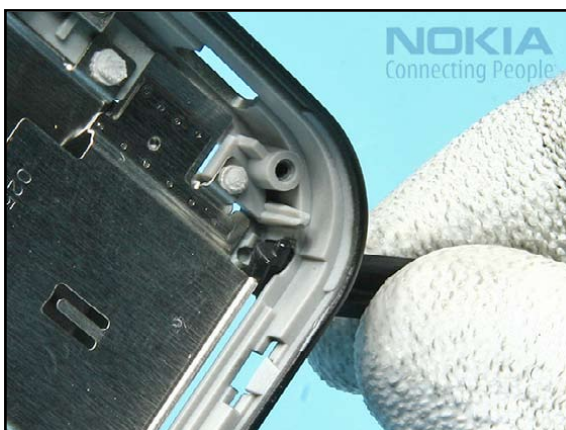

24. Open and remove the SD/MMC CARD DOOR.



25. The disassembly procedure is now completed.



**12.ASSEMBLY HINTS**



1. Take special care to the KEYMAT TOP during assembly of the B-COVER, it must not shift from its place. First align the connectors with the corresponding openings in the B-COVER, then push in the CAMERA MODULE and assemble the parts carefully.



2. Set the torque driver to the torque of 27 Ncm and tighten the Torx Plus size 6 screws in the order shown.



3. Gently, align the A-COVER with the B-COVER avoiding bending the hooks.



4. Move the shown side of the A-COVER downwards...















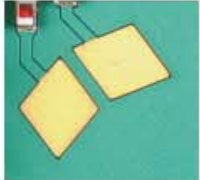

5. and carefully press it in to place.



6. Always use new screws when assembling STANDING SUPPORT PAINTED. Set the torque driver to the torque of 12 Ncm and tighten the Torx Plus size 4 screws in the order shown.

**13.LEGEND FOR QUICK TROUBLE SHOOTER**

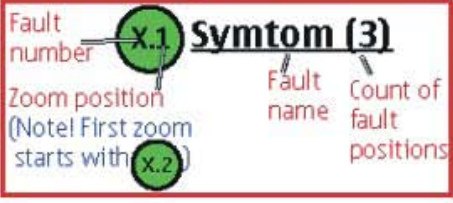

Legend for Quick Trouble Shooter	
This legend is valid for all parts of the Quick Trouble Shooter	
Follow the steps until the problem is solved. If this doesn't help, you are not authorized to go forward.	
	Check the mechanical condition of the component (bent, broken or missing).
	Only marked components can be replaced. If additionally " <b>=CHANGE ASSY</b> " appears, then change the whole assembly (e.g. A4=D-COVER ASSEMBLY).
	<b>Cloth usage:</b> Check pads or contacts for optical and mechanical condition particularly regarding to corrosion. Clean it if necessary.   
	Measure component for electrical functionality and change, if needed. (Level 2 only)  
	<b>ESD Brush usage:</b> Check contacts for optical and mechanical condition particularly regarding to corrosion. Clean it if necessary.   
	<p>Explanation</p> 

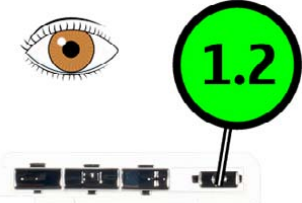

**14. QUICK TROUBLE SHOOTER - POWER ON**



**1.2**

**1.3**



**1.4**

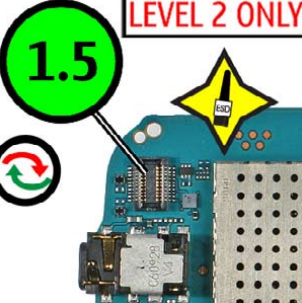

**1.5**

**LEVEL 2 ONLY**



**1.2**



**1.3**



**1.4**



**1.5**



**1.5**

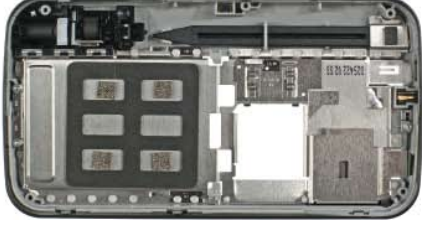

Explanation

Fault number	<b>X.1</b>	<b>Symtom (3)</b>	
Zoom position (Note! First zoom starts with X.2)		Fault name	Count of fault positions

**1.1 POWER ON (4)**

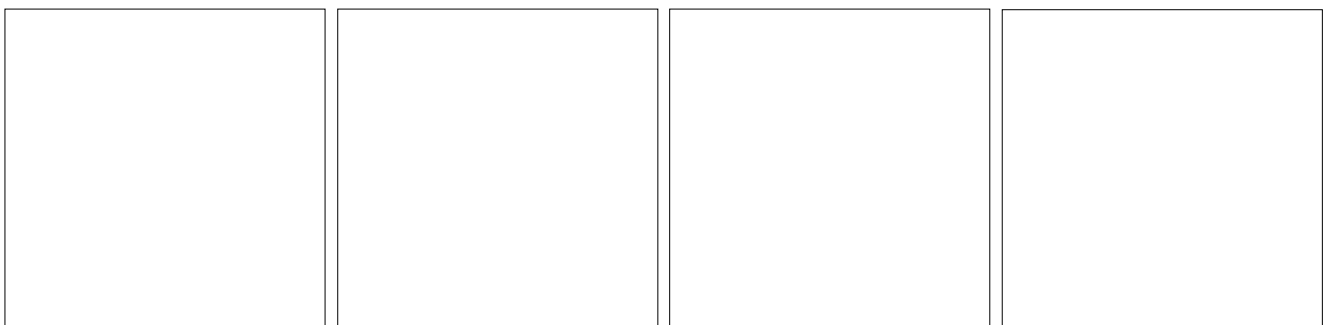

**15. QUICK TROUBLE SHOOTER - CHARGING**

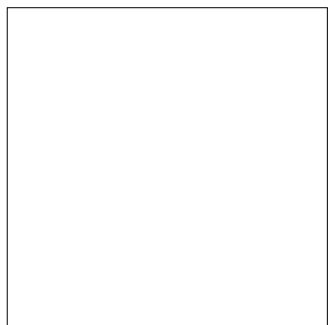
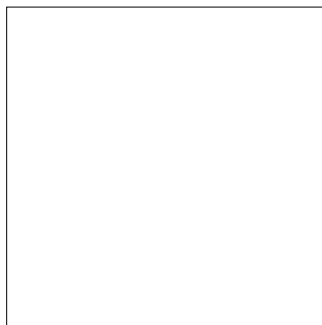
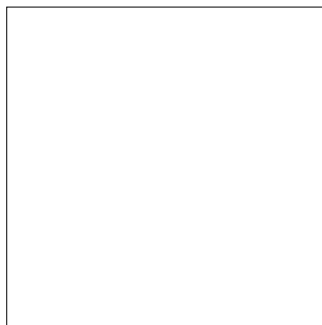
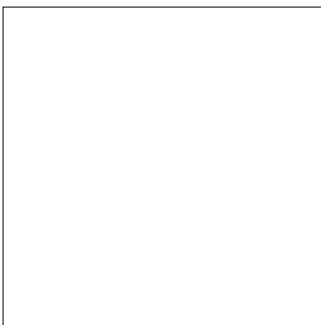
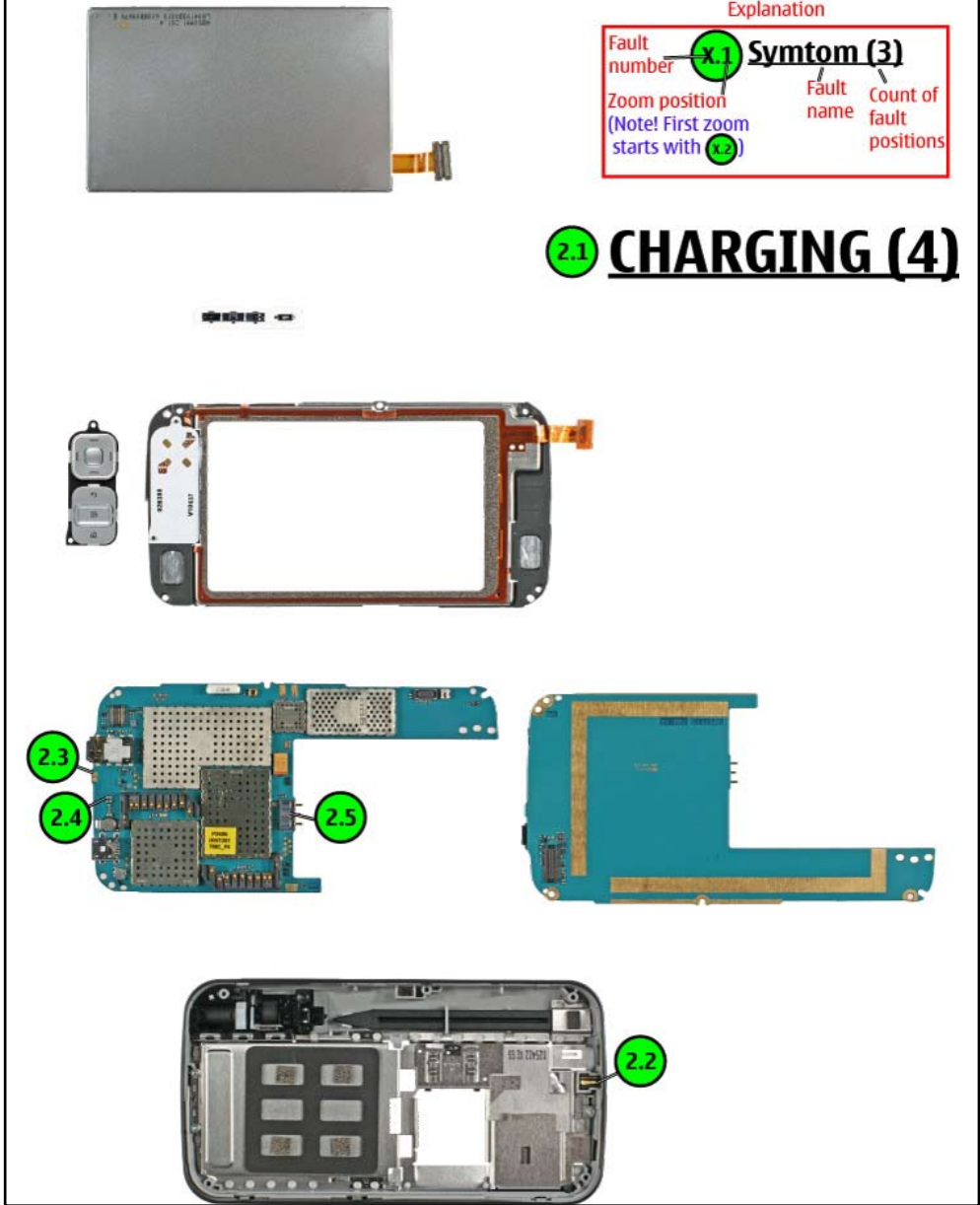
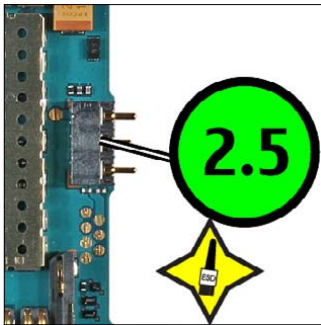
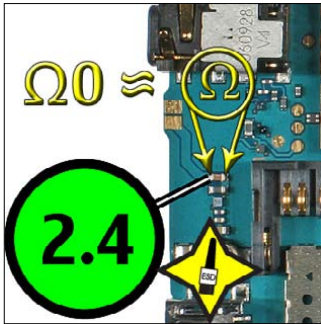
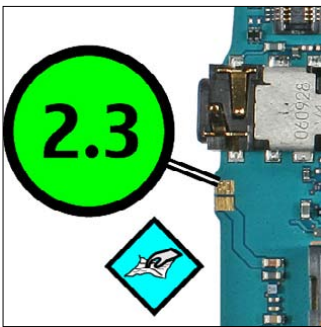
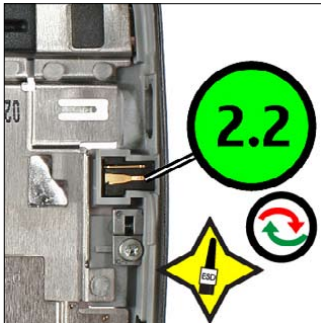

**16. QUICK TROUBLE SHOOTER - WLAN**

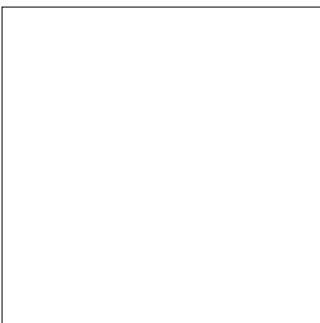
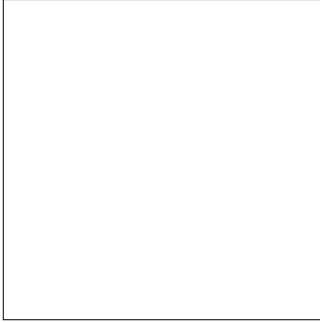
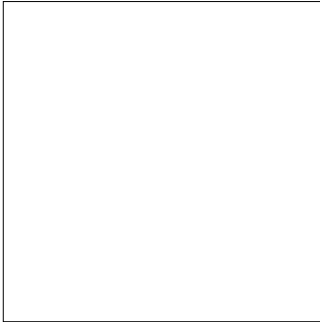
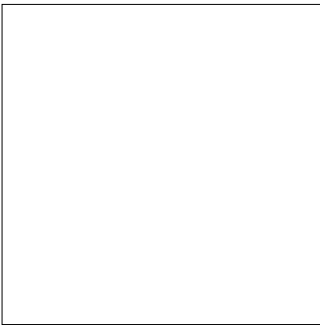
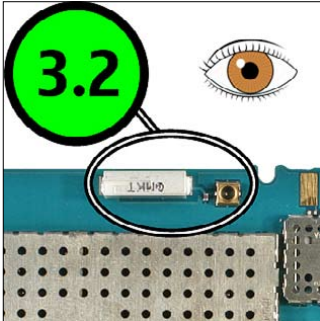



Explanation

Fault number **X.1** **Symtom (3)**

Zoom position (Note! First zoom starts with **X.2**)

Fault name    Count of fault positions

**3.1** **WLAN (1)**





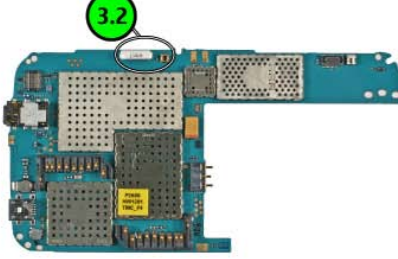

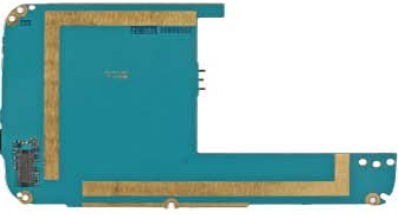

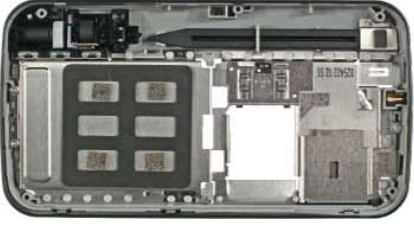

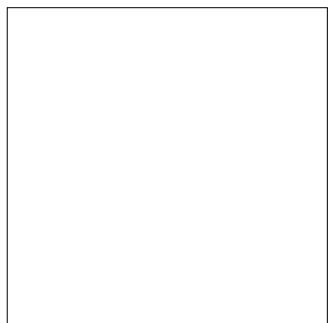
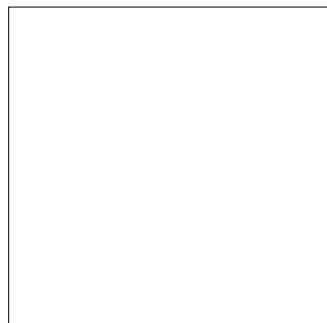
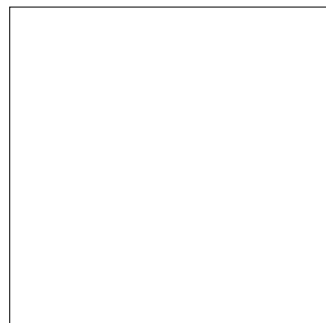



### 17. QUICK TROUBLE SHOOTER - IHF SPEAKER

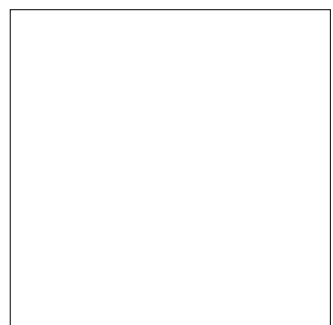
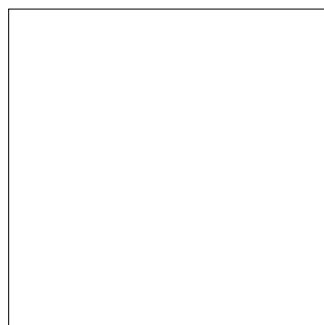
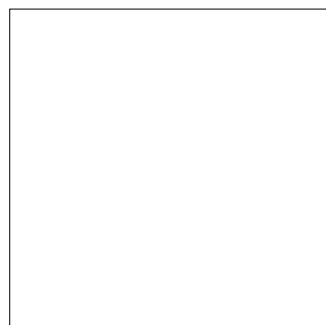
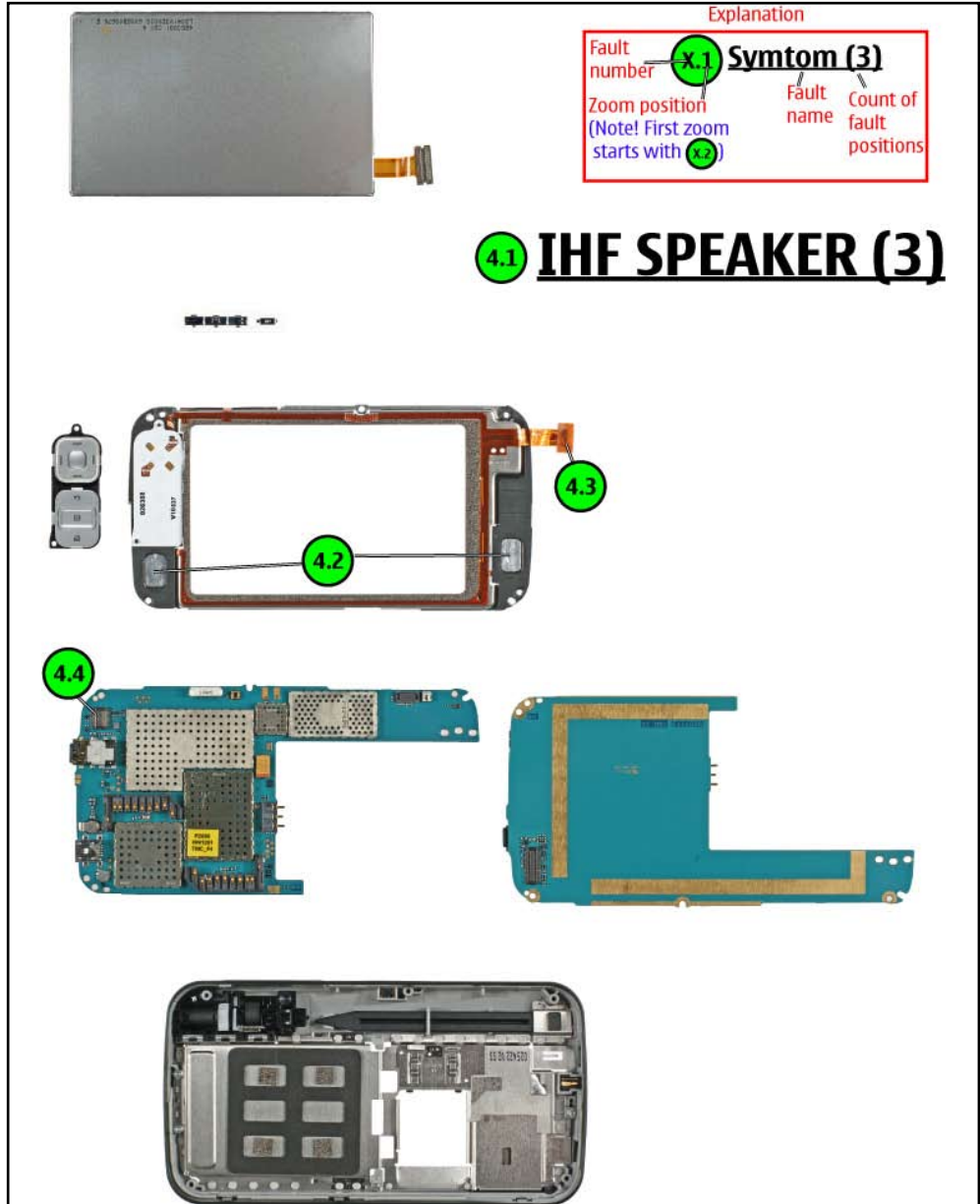
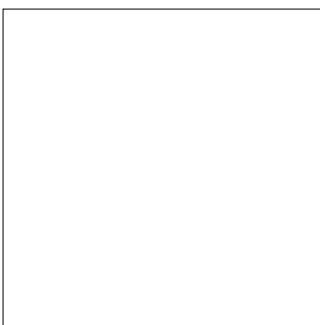
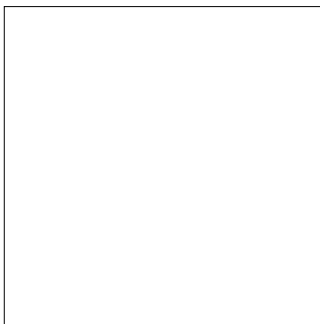
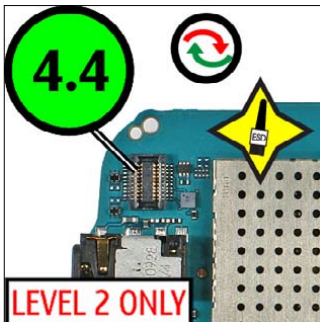
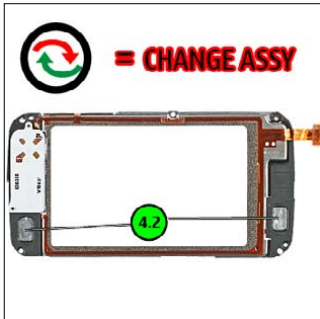

**18. QUICK TROUBLE SHOOTER - DISPLAY**

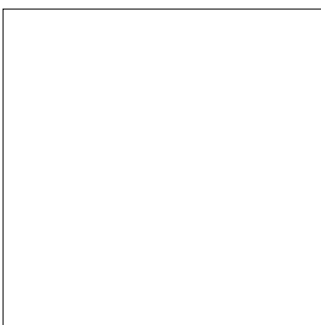
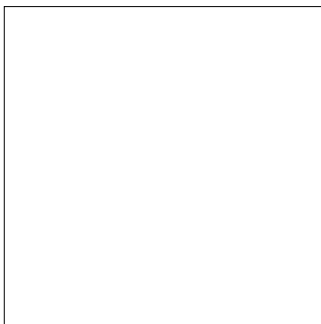
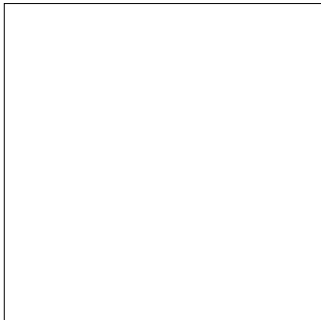
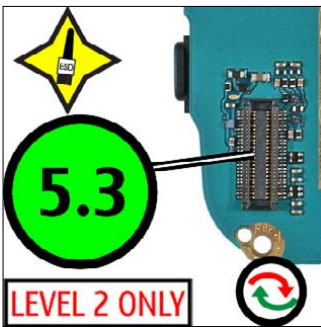
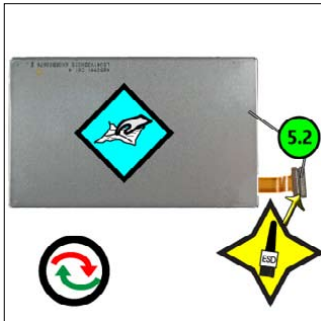

Explanation

Fault number	X.1	<b>Symtom (3)</b>	
Zoom position (Note! First zoom starts with X.2)		Fault name	Count of fault positions

5.1 DISPLAY (2)

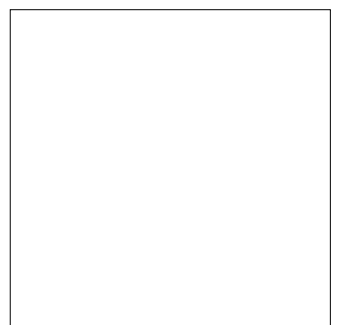
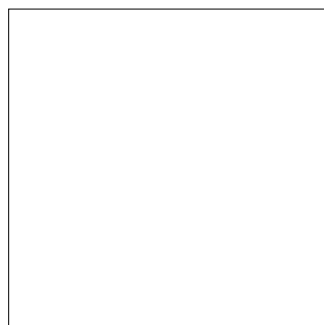
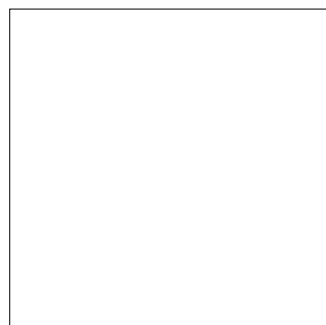

## 19. QUICK TROUBLE SHOOTER - MICROPHONE

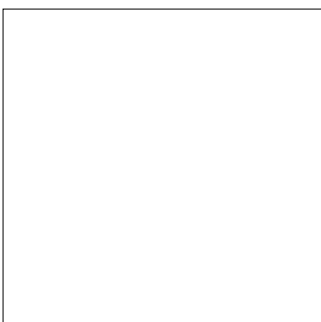
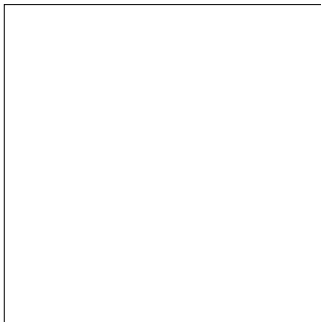
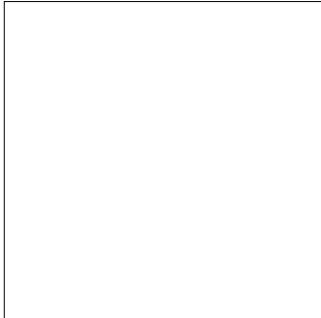
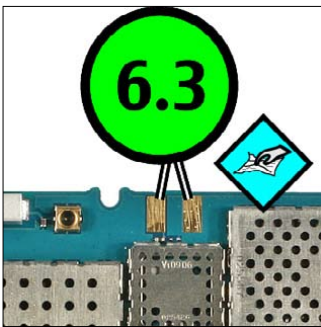

Explanation

Fault number	X.1	<b>Symtom (3)</b>	
Zoom position (Note! First zoom starts with	X.2	Fault name	Count of fault positions

6.1 **MICROPHONE (2)**

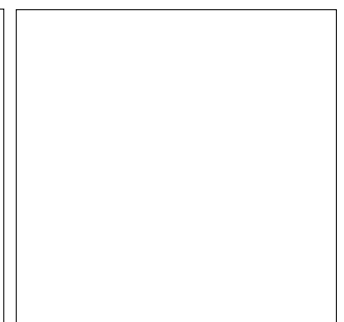
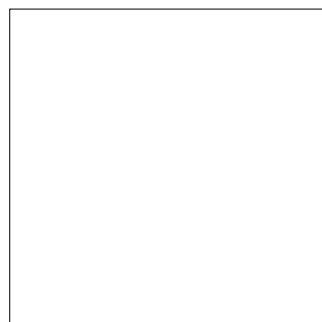



**20. QUICK TROUBLE SHOOTER - KEYMAT FRONT**

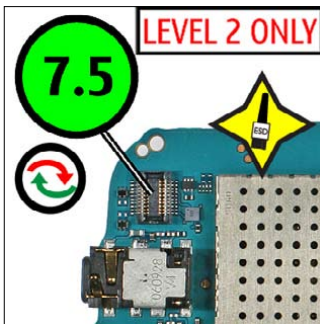



**7.1**

Explanation

Fault number	X.1	<b>Symtom (3)</b>
Zoom position (Note! First zoom starts with X.2)	X.2	
	Fault name	Count of fault positions

**7.1 KEYMAT FRONT (4)**

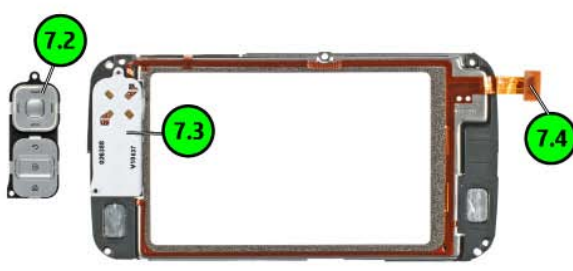

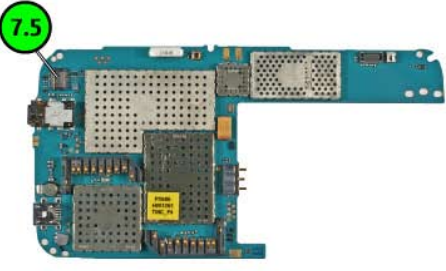

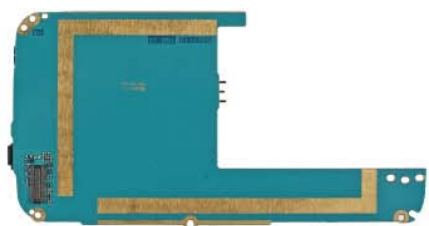

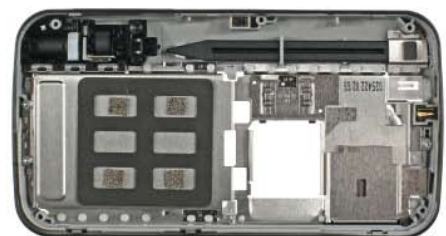

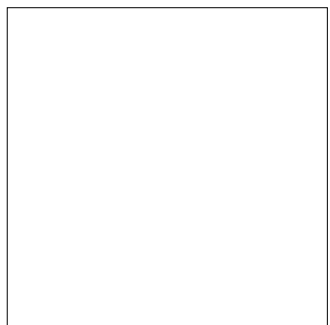
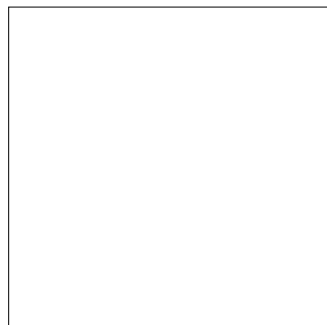
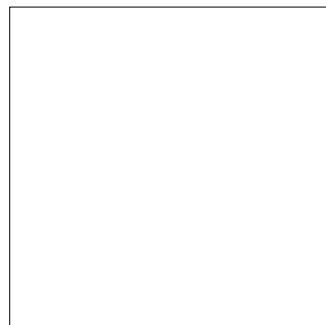
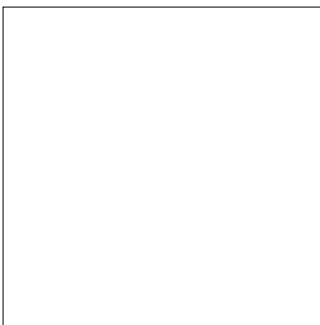



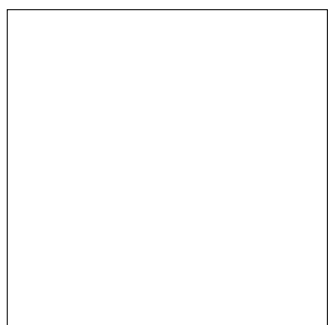
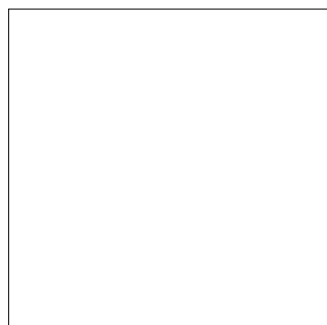
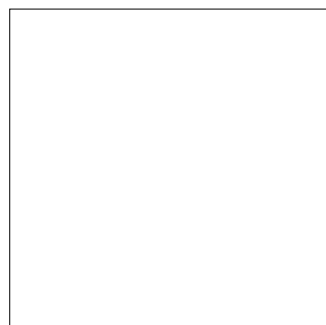
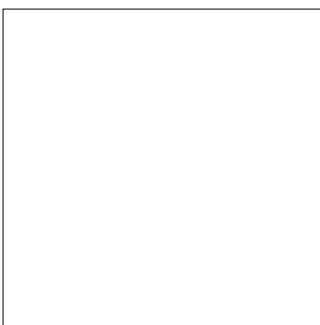
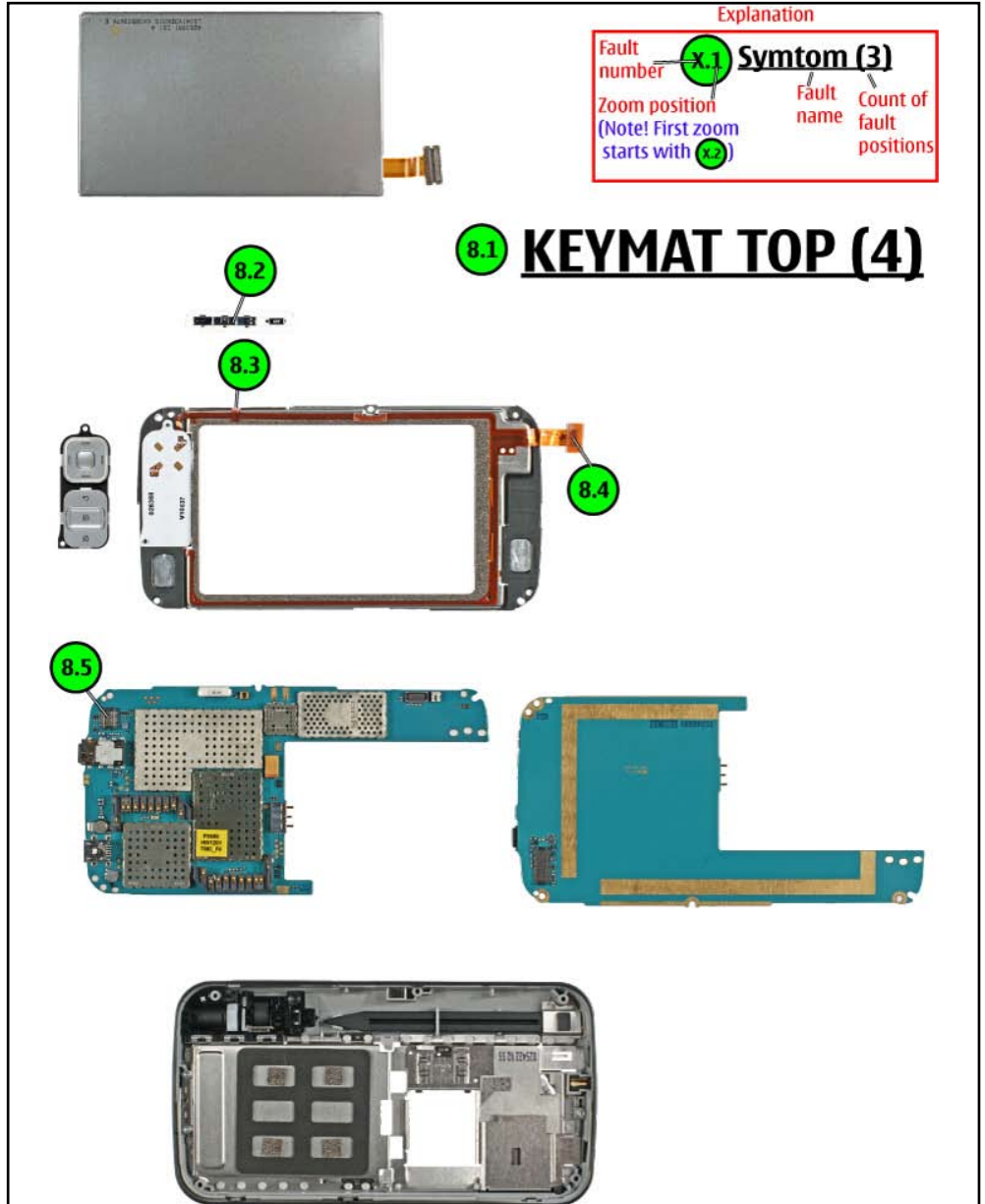
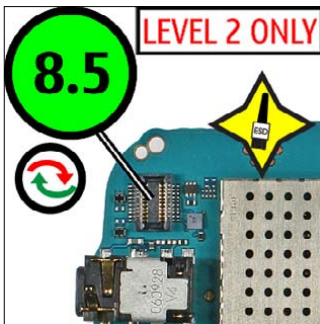
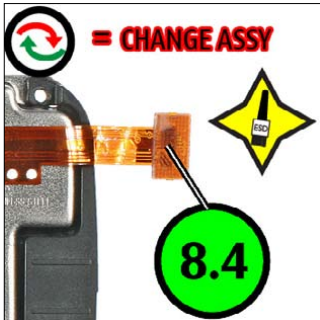
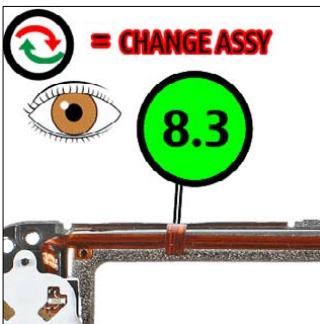
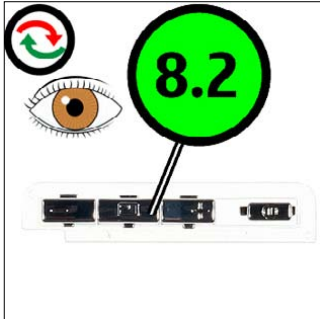

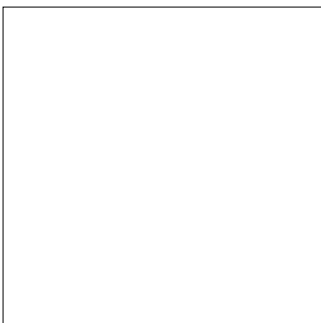
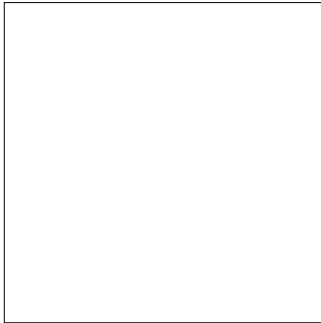
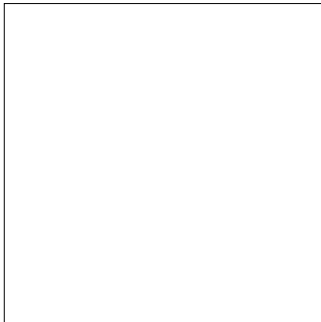
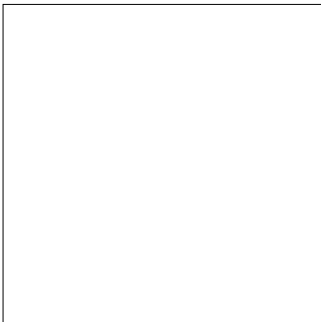
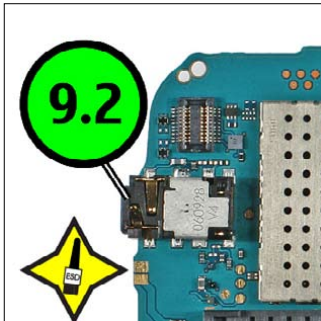

## 21. QUICK TROUBLE SHOOTER - KEYMAT TOP



## 22. QUICK TROUBLE SHOOTER - AV CONNECTOR



Explanation

Fault number	X.1	<b>Symtom (3)</b>	
Zoom position (Note! First zoom starts with X.2)	X.2	Fault name	Count of fault positions

9.1 AV CONNECTOR (1)



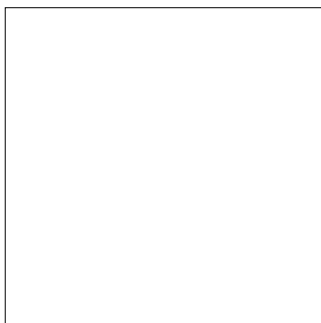
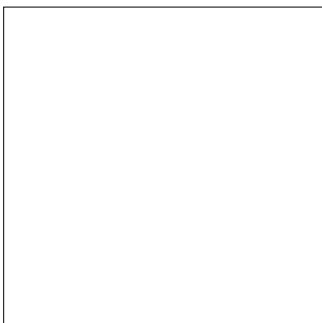
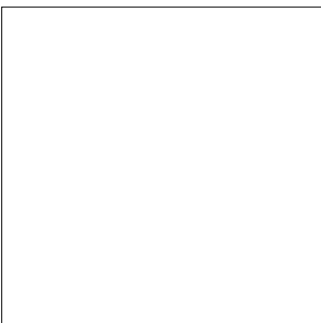

## 23. QUICK TROUBLE SHOOTER - USB CONNECTOR

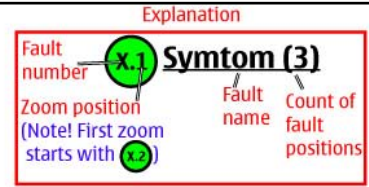
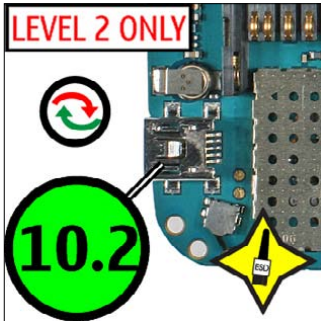

### 10.1 USB CONNECTOR (1)

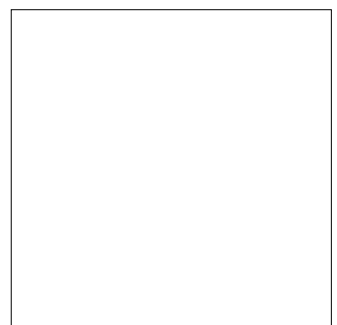
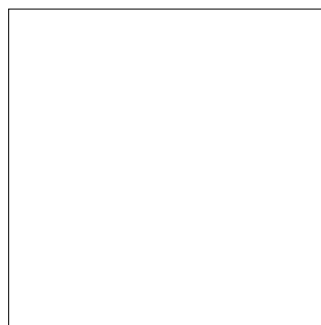
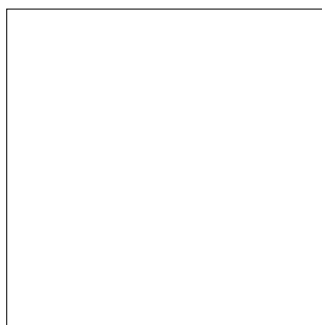
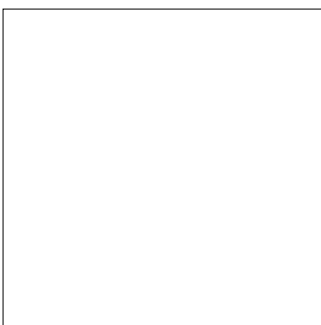
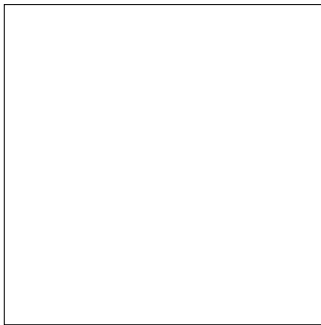
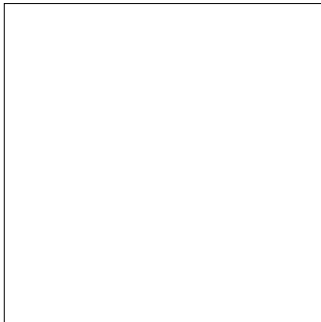
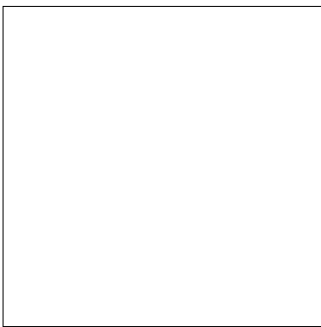
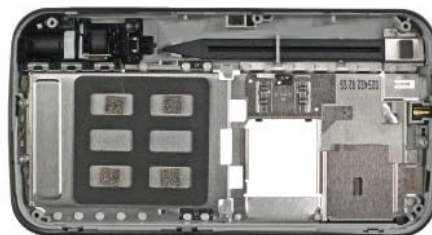
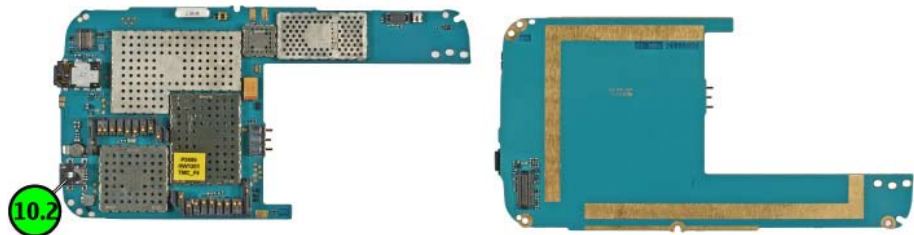

**24. QUICK TROUBLE SHOOTER - CARD READER**

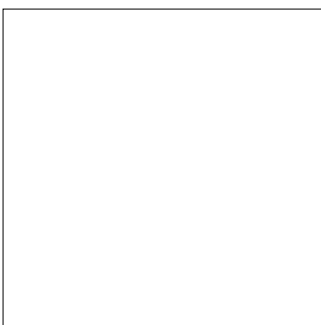
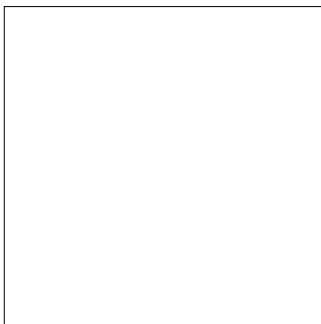
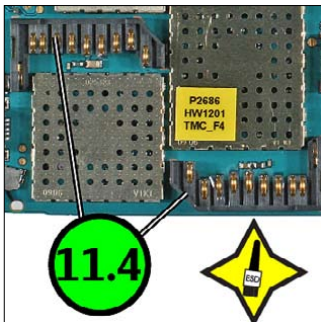
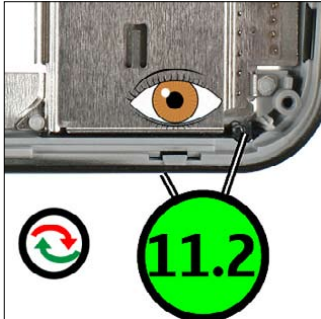



Explanation

Fault number	X.1	<b>Symtom (3)</b>		
Zoom position (Note! First zoom starts with	X.2)	Fault name	Count of fault positions	

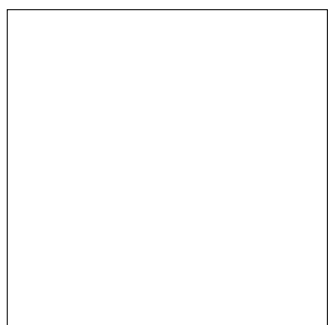
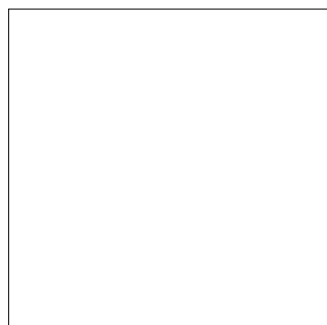
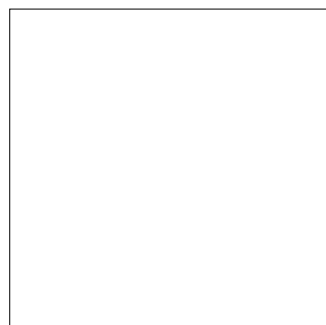
11.1 CARD READER (3)

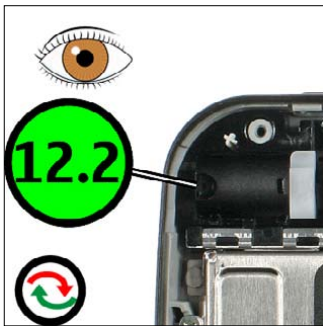

## 25. QUICK TROUBLE SHOOTER - CAMERA

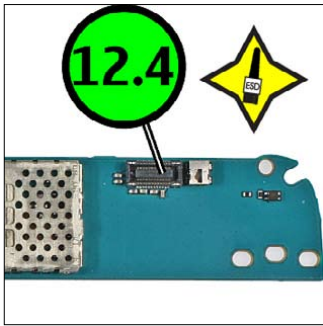
How to measure 4-pal switch (built-in)

↑ open  
≈ ∞ Ω  
↓ pressed  
≈ 0 Ω

MEASURE OPEN AND PRESSED STATE ON BOTH SIDES OF THE SWITCH



**LEVEL 2 ONLY**

Explanation

Fault number	X.1	<b>Symtom (3)</b>	
Zoom position (Note! First zoom starts with X2)	X.2	Fault name	Count of fault positions

12.1 CAMERA (4)

